

**BEDNAR**  
FARM MACHINERY



*A fast and high quality stubble tillage solution*

**SWIFTERDISC**  
XN, XO\_F, XE

+ **ALFA DRILL**

### MAIN ADVANTAGES OF THE MACHINE

- **Excellent machine stability** without unwanted movement thanks to the well balanced centre of gravity.
- **Operating speeds of 15 km/h or more** thanks to the cleverly located axle.
- **The set tillage depth is constantly maintained.** The weight is distributed consistently on the discs, even for the 12 m machines (SwifterDisc XE 12000).
- **Profiled A-discs** of 520x5 mm diameter guarantee **intensive mixing and cutting of crop residue.**
- **The machine has a high material throughput thanks to its Twin-Disc system,** one arm for every two discs.
- **Maintenance-free bearings of discs** are on standby for the toughest conditions.
- **A front hydraulic levelling bar – Crushbar for seedbed preparation** (model XO\_F, XE).

### AGRONOMIC ADVANTAGES OF THE MACHINE

- The stubble cultivated immediately after the harvest **takes advantage of the higher soil moisture content.**
- Fast stubble tillage forms the foundation for a **managed germination process of second growth and weeds following the harvest.**
- Shallow tillage means **greater humus content** in the upper soil layer creating a more permeable soil (no soil crust).
- **Fine crumbling** due to the high speed of the machine and the resulting high circumferential speed of the packers, which delivers a flatter field without clods.
- **Compaction of the cultivated surface** ensures the even germination of volunteer plants and weeds.
- **Agrotechnical deadlines are met** as a result of the machine's high performance and coverage.
- **All-purpose tool for stubble tillage,** soil preparation and intercropping with an Alfa Drill.

**BEDNAR SWIFTERDISC** is a short disc cultivator which was developed for uniform cultivation in order to maximise the mixing quality of soil and plant residue, creating a homogeneous material with the plant residue decomposing quickly and evenly. All of this at high operating speeds, which have a positive impact on the tilling quality.

The compact SwifterDisc cultivator is particularly suitable for shallow tillage with intensive soil mixing. By placing the discs on flexible rubber segments the uneven terrain is tracked and the Twin-Disc system guarantees an excellent material throughput. Superior tillage quality is ensured with the aggressive A-discs (520x5 mm) which function at high operating speeds.

The SwifterDisc provides swift and affordable soil cultivation. The time spent tilling fields is significantly shortened and the overall costs for cultivation and fuel are reduced.



*"In recent years, I've spent a lot of time in the field talking to short disc tool users and the most recurring topic that came up, was machine stability problems. It was the stability of the short disc cultivators which affected the overall performance. The set up couldn't achieve the performance it should have as the short disc was unstable. So we sat down with our designers and carefully tested different centres of gravity so that the operating speed would be limited not by the tool, but by the tractor. We succeeded by using our integrated axle for the SwifterDisc XO\_F and by moving the axle on the SwifterDisc XE in front of the disc sections."*

Jan Bednar

SWIFTERDISC  
**Benefits**



SWIFTERDISC  
**Utilisation**



**Cost savings benefits:**

- **Quality tillage in one pass** – one pass instead of many, quality cutting, mixing and incorporation of plant residue due in particular to the profiled aggressive A-discs.
- **High operating speeds** – means cutting costs and the number of hours spent out on the field. The high speeds are reached thanks to the high stability of the machine.
- **Large area capacity** – SwifterDisc is a light disc cultivator which can be connected to tractors of lower output, while the operating width and operating speed guarantee unusually high performance.
- **Low maintenance costs** – the components have a longer lifespan.

**You can use the SWIFTERDISC for:**

- **Shallow and fast stubble tillage** to stimulate volunteer plant and weed germination and prevent capillary action.
- **Maintain the moisture in the soil** by compacting the surface with a rear packer immediately after the harvest.
- **Seedbed preparation** which includes levelling the furrow.
- **The incorporation of plant material** such as intercrops.
- **Planting intercrops and grasses** using an Alfa Drill.



An agricultural co-operative located in Suchdol district Pribram (Czech Republic) 

area: 1 295 ha  
machine: SwifterDisc XO 6000 F

*"The machine breaks up clods and levels the land perfectly. I must say that I am very pleased with this new machine, because its stability is excellent even at higher speeds of over 15 km/h."*

Jaroslav Skala, chairman

**DEMONSTRATION ON GRAIN STUBBLE FIELD**

- machine: SwifterDisc XE 10000
- cultivation depth: 7 cm
- number of passes: 1
- working speed: 18 km/h
- fuel consumption: 6,5 l/ha



**A DEMONSTRATION ON THE ROUGH FURROW**

- machine: SwifterDisc XO 6000 F
- cultivation depth: 12 cm
- number of passes: 1
- working speed: 10 km/h
- fuel consumption: 9 l/ha



*„Better, faster and more economical”*

SWIFTERDISC  
**Operating components**



SWIFTERDISC  
**Precise stubble cultivation**



**Why should the cultivation be done immediately after the harvest**

The foundations for successful crop growth are laid when harvesting the previous crop. By tilling the stubble immediately after harvest, you can use the moistness of the soil, which was protected from the sun by the stems. Fast tilling ensures the reliable and even germination of volunteer plants and weeds. The basis for success here is a short interval between the harvest and sowing. Whether the farming is done by using a minimum-tillage system or a conventional method it is irrelevant.

**Stable tillage, flat land**

For tillage, a level surface must be maintained both horizontally to the direction of work and along the direction of work. To achieve flat land without mounds, the machine must operate smoothly and in a stable manner. Any unwanted movement of the machine through, e.g. rocking, creates an uneven field. Till with the stable SwifterDisc with its cleverly positioned centre of gravity.

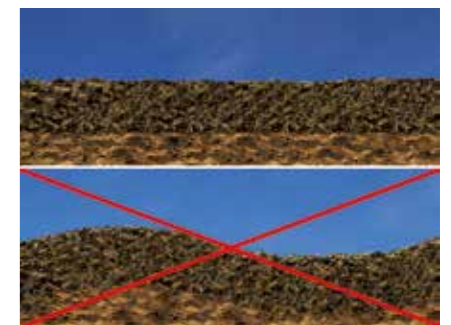

**A DISC DIAMETER OF 520x5 MM**

The standard model of SwifterDisc cultivators is fitted with serrated discs with a dimension of 520x5 mm. For an additional fee, you can have the machine fitted with aggressively profiled A-discs.



**MAINTENANCE-FREE AXIAL BEARINGS**

Axial ball bearings with oblique contact are encased with two static, one dynamic cassette and four rib seals in a solid metal body.

- 1 – dynamic cassette sealing with four ribs,
- 2 – metal body, 3 – static sealing,
- 4 – four-point bearing, 5 – double sealing

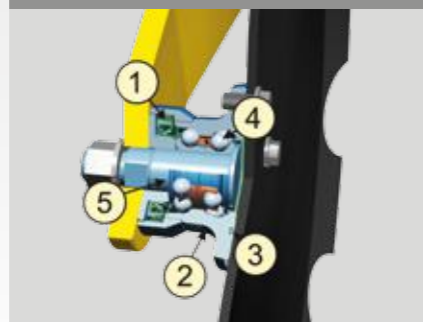

**SECURING OF DISCS**

Rubber segments prevent bumps created during soil tillage. The machine functions quickly without maintenance regardless of tough conditions. High quality, long-life rubber is used!



**SIDE SHIELDS**

SwifterDisc machines can be equipped with side shields (discs) which prevent the formation of ridges around the edges of the machine. Individual passes cannot be seen.



**FRONT HYDRAULICAL PADDLE LEVELLING BARBAR – CRUSHBAR**

The SwifterDisc XO\_F and XE models can be fitted with a front hydraulic paddle levelling bar – Crushbar (excellent for seedbed preparation). It levels out the land including the rough furrow in front of the discs.



**HYDRAULICALLY CONTROLLED WORKING DEPTH**

The working depth can easily be set using the roller control, or the front supporting wheels. It can be set mechanically or hydraulically.



„It all comes down to performance”

SWIFTERDISC  
Packers and rollers



**TUBE**

The basic SwifterDisc model is equipped with a tube packer. This kind of packer is a good value solution and is particularly suitable for light soils.

weight: 110 kg/m  
diameter: 635 mm



**STEEL RING**

The heavy steel ring packer is suited to all types of soils for aggressive consolidation and clod crumbling. The individual segments are made of special smear proof steel. The packers are equipped with adjustable scrapers.

weight: 177 kg/m (including the scraper system)  
diameter: 525 mm



**ROADPACKER**

The Roadpacker packer is a full bodied roller made of hard natural rubber and is suitable for all conditions. The levelling effect of the packer's weight is excellent. The packer zero adhesion to the soil is made possible by rubber and scrapers.

weight: 193 kg/m (including the scraper system)  
diameter: 585 mm



**TYREPACKER**

A packer made up of tyres (27x8,5 15 8PR) suitable for medium heavy soils with a good throughput in wet conditions.

weight: 180 kg/m  
diameter: 700 mm



**SPRING**

The Spring packer crumbles very well and reduces the blockage risk for the more moist soils. The springs work intensively – crumbling and mixing whilst still pushing down on the soil.

weight: 134 kg/m  
diameter: 530 mm



**V-RING**

As the name implies the V-ring arch packer is V-shaped. There is less adhesion of the parts on the packer. The effect is enhanced by adjustable scrapers, which prevent clogging.

weight: 160/176 kg/m (including the scraper system)  
diameter: 530/630 mm



**U-RING**

The tube rollers work in tandem which crumble and break up the soil extremely well. The rollers, which are small in diameter, achieve high circumferential speeds, producing a rotary cultivator effect.

weight: 130/155 kg/m (including the scraper system)  
diameter: 500/600 mm



**DOUBLE U-RING**

A double row steel packer with self-cleaning effect with excellent crumbling and low adhesion thanks to the U-shaped ring profile.

weight: 126/163 kg/m  
diameter: 500/600 mm



**DOUBLE PACKER**

Ideal for high-quality two-step processing of medium and light soils in drier conditions.

weight: 238 kg/m  
diameter: 370/470 mm

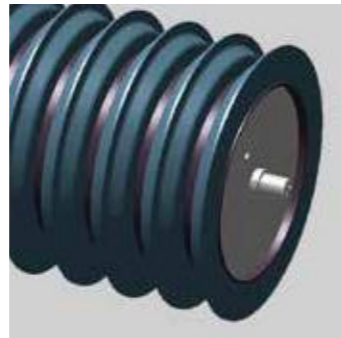

**CUTPACK**

Heavy steel packer with powerful cutting capabilities suitable for heavy soils.

weight: 235 kg/m (including the scraper system)  
diameter: 630 mm

SWIFTERDISC  
Better quality work



**A-DISCS: A new dimension to work quality**

Specially shaped discs of 520 mm in diameter and a wall thickness of 5 mm with significantly high cutting and mixing abilities compared to other classic cutting discs. A-discs have a large number of blades around their circumference for the easy incorporation of large amounts of crop residue. These sharp blades cut up the crop residue efficiently. The profiled shape also allows a larger amount of soil to be lifted up than with standard serrated discs. Each profiled disk takes soil and takes it to the plant mulch where it is mixed. This concept delivers excellent results.

**THE TWIN-DISC ENSURES A BETTER THROUGHPUT**

The discs work in pairs on one arm. This solution means the distance between each arm is larger (50 cm). This results in more space for the material to pass through the machine. The machine can work smoothly even when the combine has left clumps of straw on the field. SwifterDisc cuts it up, spreads it out, mixes it with soil and covers it.



## SWIFTERDISC XO\_F

The tractor, not the tool, controls the operating speed...  
...with increasing speeds, the quality of work increases too!

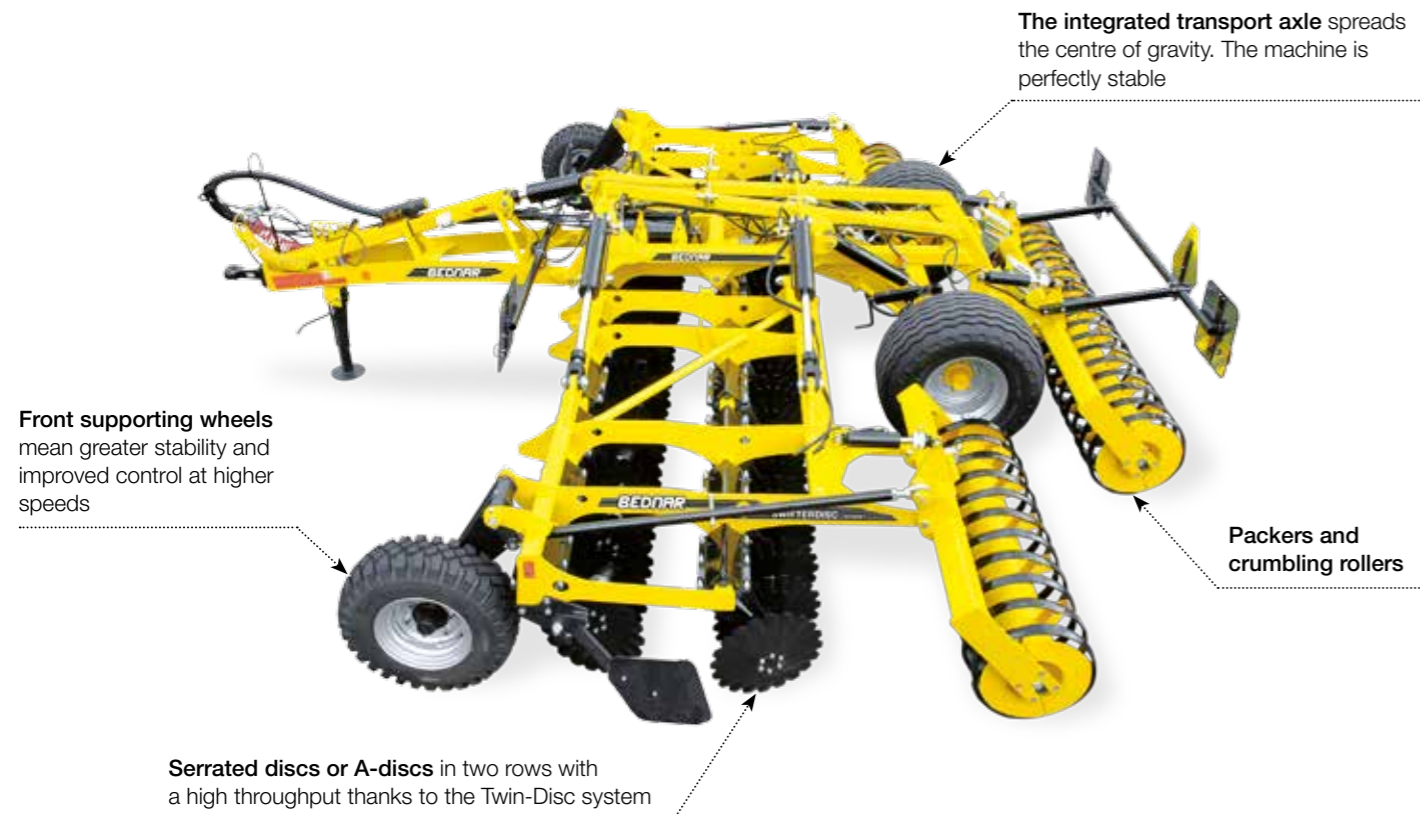

## SWIFTERDISC XN

A compact cultivator for smaller fields and hilly terrain...  
...short, adept and fast = a good cultivator!

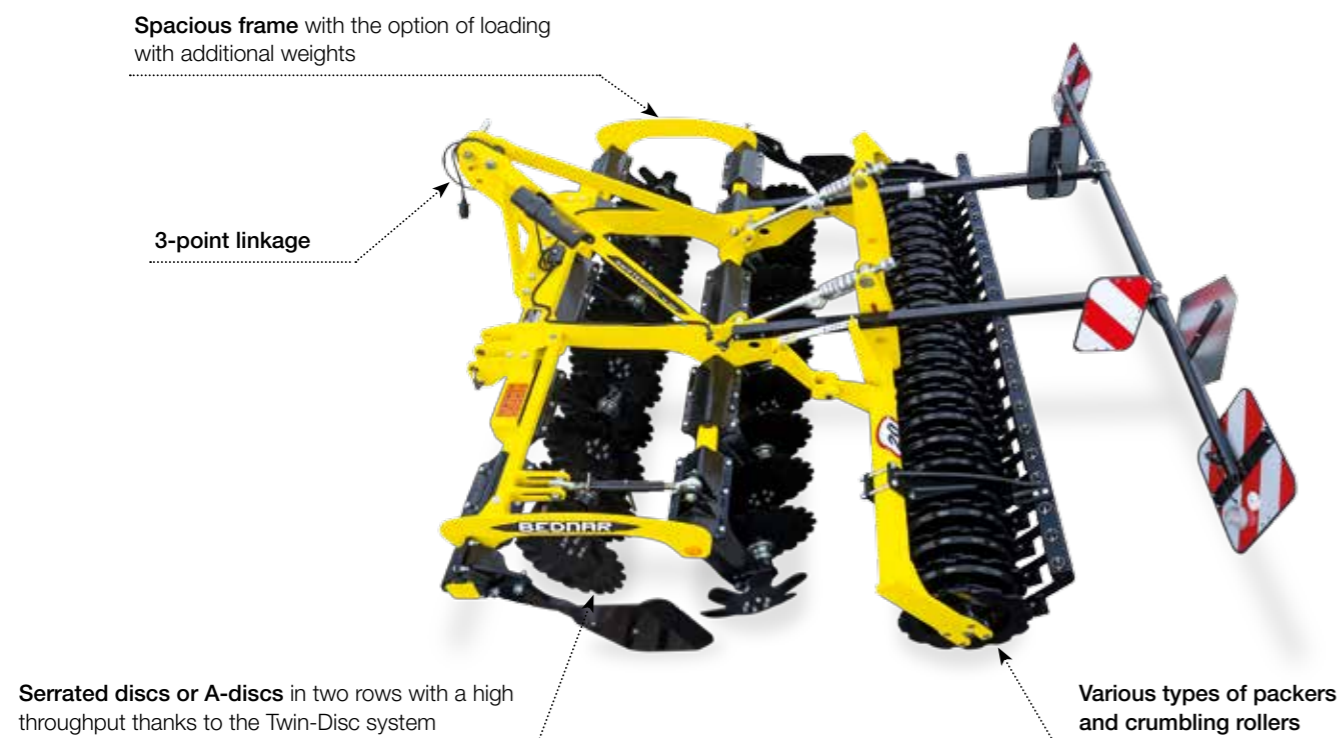

## SWIFTERDISC XE

An exact working depth over the cultivator entire operating width... speed unlimited!

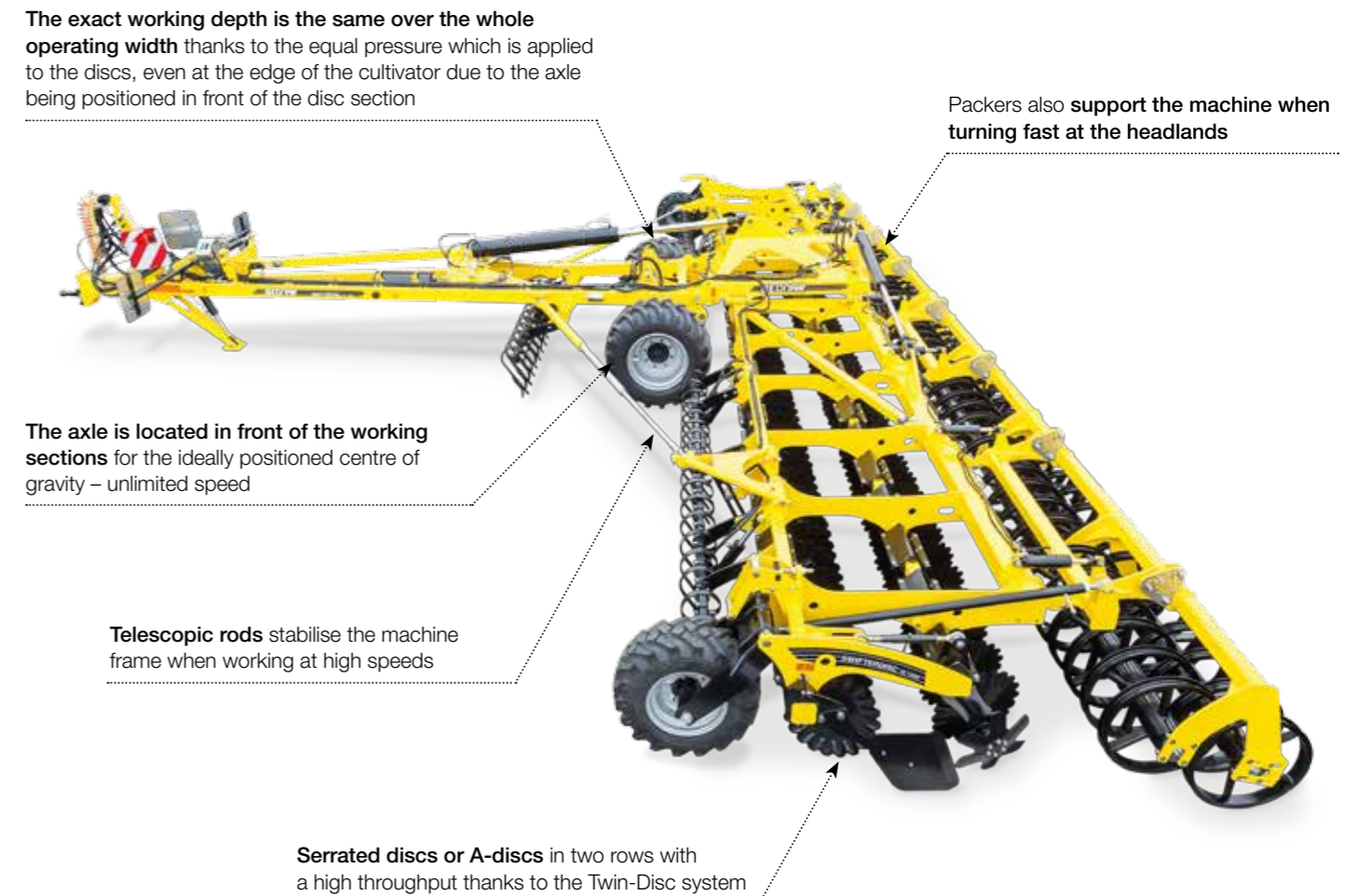

Lupofyt s.r.o. Chrastany  
district Rakovnik (Czech Republic)   
area: 1 940 ha  
machine: SwifterDisc XE 10000

*"What stands out for me as a great benefit of the machine compared to its competitors is its stability and sturdiness, even at higher speeds; the machine doesn't jump, working depth is always the same evenly over the whole profile and thanks to its high working speed it covers the plant residue perfectly, never mind its daily output."*

Milan Hlavacek, machine operator

## SWIFTERDISC XN series



**BEDNAR SWIFTERDISC XN** is a disc cultivator suitable for tractors ranging from 85 to 220 HP

- mounted machine
- operating widths of 3, 3.5, 4, 5, 6 m
- rigid or folds upwards, having two side frames

SWIFTERDISC		XN 3000	XN 3500	XN 4000	XN 4000R	XN 5000	XN 6000
Working width	m	3	3,5	4	4	5	6
Transport width	m	3	3,5	3	4	3	3
Transport length	m	3	3	3	3	3,3	3,3
Working depth*	cm	2-12	2-12	2-12	2-12	2-12	2-12
Number of discs	pcs	24	28	32	30	40	48
Total weight**	kg	1 650-2 050	1 800-2 200	2 390-3 240	2 035-2 430	3 000-3 900	3 600-4500
Recommended output*	HP	85-115	110-130	130-150	130-150	150-180	180-220

\*depends on soil conditions \*\*depends on the machine accessories

## SWIFTERDISC XO\_F series



**BEDNAR SWIFTERDISC XO\_F** is a disc cultivator suitable for tractors ranging from 120 to 320 HP

- semi-mounted machine
- operating widths of 4, 4.5, 5, 6, 7.5 m
- folds upwards having two side frames

SWIFTERDISC		XO 4000 F	XO 4500 F	XO 5000 F	XO 6000 F	XO 8000 F
Working width	m	4	4,5	5	6	7,5
Transport width	m	3	3	3	3	3
Transport length	m	6,4	6,4	6,4	6,4	6,5
Working depth*	cm	2-12	2-12	2-12	2-12	2-12
Number of discs	pcs	32	36	40	48	60
Total weight**	kg	3 900-5 000	4 100-5 100	4 300-5 300	4 600-5 600	5 700-6 940
Recommended output*	HP	120-150	140-170	160-190	190-220	240-320

\*depends on soil conditions \*\*depends on the machine accessories

### 3-POINT LINKAGE

Connect it to the tractor quickly and effortlessly by using a 3-point linkage.



### EASILY ADJUSTABLE WORKING DEPTH

It is easy to set the working depth by using hydro-clips. A constantly maintained working depth guarantees high quality tillage.



### COMFORTABLE TRANSPORT

Transport on public roads and through the fields is comfortable and safe.



### FRONT SUPPORTING WHEELS

The supporting wheels help maintain a constant working depth even at high operating speeds. It also helps prevent the machine from rocking.



### THE INTEGRATED AXLE

The axle located in front of the packers balances the centre of gravity and reduces the turn radius at the headlands.



### FOLDING THE MACHINE

The SwifterDisc XO\_F can be folded upwards along the central frame, having two side frames. It has a transport width up to 3 m.



# SWIFTERDISC XE series



**BEDNAR SWIFTERDISC XE** is a disc cultivator suitable for tractors ranging from 300 to 450 HP

- a trailed machine
- operating widths of 10 and 12 m
- folds forwards along the drawbar

SWIFTERDISC		XE 10000	XE 12000
Working width	m	10	12
Transport width	m	3	3
Transport length	m	7,5-8,7	8,1-9,2
Working depth*	cm	2-12	2-12
Number of discs	pcs	80	96
Total weight**	kg	7 700-9 300	8 600-10 800
Recommended output*	HP	300-350	400-450

\*depends on soil conditions \*\*depends on the machine accessories

## TURN BY USING REAR PACKERS

At the headlands, the machine can turn using the rear packers. Fast, easy, effective.



## FOLDS FORWARD

The operating section can easily be folded forwards along the drawbar, giving the machine very small transport dimensions.



## A COMPACT TRANSPORT SIZE

Its compact transport size assures you of simple transport along public roads - the machine length is 8.6 m, operating width of 12 m and transport width of 3 m.



# DRILL MACHINE ALFA DRILL

## CORE BENEFITS

- Sows cover crops and grasses, combines the workflows.
- Limits soil erosion.
- Weed disposal.
- Increases the nitrogen in the soil due to the cover crops.
- Improves the soil structure by inter-cropping.
- Increases biological activity.



**ALFA DRILL** is a seed drill unit for sowing cover crops or grasses and can be mounted on various types of BEDNAR machines. The hopper which has a capacity of 200 l is easily accessible via a comfortable stairway, allowing for an easy refill. In the area under the metering system we can find the metering shaft, which can, depending on type of seeds or on quantity of seeding volume, be equipped with standard metering rollers or rollers for fine seeds.

ALFA DRILL		ALFA 3000*	ALFA 4000	ALFA 5000	ALFA 6000
Working width	m	3	4	5	6
Number of hoses	pcs	8	8	8	8
Fan		electric	electric	electric	electric/hydraulic
Capacity	l	200		200	200
Total weight	kg	290**	445***	455***	460***

\*only designed for Terraland TN 3000 RT

\*\*weight including distributions and supporting frame

\*\*\*weight including distributions, supporting frame and weights balance for the drawbar (200 kg)



SIMPLE AND SAFE ACCESS TO THE HOPPER



DISTRIBUTION TERMINAL



HOPPER 200 L



# Product range

T: +420 283 092 529  
 E: info@bednarfmt.com  
 W: www.bednar-machinery.com

**BEDNAR FMT s.r.o.**  
 Lohenická 607  
 190 17 Praha 9 - Vinoř  
 Czech Republic



The technical data and illustrations are approximate.  
 Reservations are made for any design changes.

## TILLAGE

Straw harrows STRIEGEL-PRO



Disc cultivators SWIFTERDISC



Disc cultivators ATLAS



## TILLAGE

Seedbed cultivators SWIFTER



Versatile cultivators FENIX



Chisel ploughs TERRALAND



## TILLAGE

Trailed packers  
 CUTTERPACK, PRESSPACK, GALAXY



## INTER-ROW CULTIVATION

Inter-row cultivator ROW-MASTER



## SOWING AND FERTILISING

Seed drills OMEGA



Fertiliser hopper FERTI-BOX



## ROTARY CUTTERS

Rotary cutters MULCHER



\* K M 6 0 0 3 7 9 \*

Your authorised dealer